

The original hardware wallet.

Trezor One is the world's first hardware wallet, invented to keep your bitcoins safe. Over time, it evolved into a powerful cryptocurrency wallet, with support for various coins and tokens, it can also be a password manager for your convenience. The Trezor One is a pioneer of its category, trusted and used by many satisfied users around the world. Its design incorporates a detailed display for verification of all operations and buttons for physical confirmation. All processes are run on the internal CPU, isolating your confidential data from the internet. The original Trezor is a solid hardware wallet choice for all. For more information, please visit trezor.io

Features



Multicurrency



PIN/Passphrase



Easy backup



Password manager



U2F



SSH



GPG



Transparent security



Intuitive interface



5-star customer support

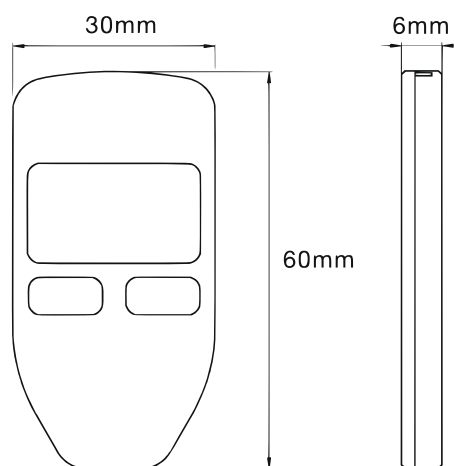

Designed and built in EU 

MSRP: 89 EUR

Technical info

Size

60 mm x 30 mm x 6 mm
2.4 in x 1.2 in x 0.2 in

Weight

12 g
0.42 oz

Display

Monochrome display
128 x 64 px

Connectivity

microUSB

Processor

120 Mhz Cortex-M3

Safety & certifications







CE and RoHS certifications
Airplane and X-ray safe

Features – detailed description

Coins

BTC, LTC, DASH, Zcash, NEM, ETH,
ERC-20, ETC, BCH, +200 others
See trezor.io/coins

Security protections

Secure PIN entry via  
Secure passphrase via  
Secure device recovery via  

Password manager

Encrypted storage on cloud

Authentication token

SSH
U2F

Encryption

GPG

Compatible with

Windows 8 and later,
macOS 10.13 and later,
Linux LTS versions, Android 4
and later